

Product Code: CU1MCB32B

Luckinslive 425300220

Description: 1 Pole True 6kA B Curve 32A MCB

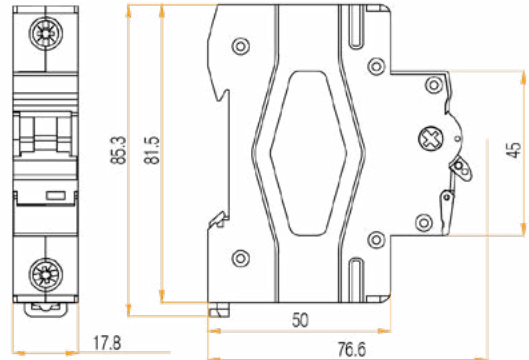

### General Information

Dimensions (mm)	17.8 (W) x 85.3 (H) x 76.6 (D)
Colour	Light Grey
Rated Operational Voltage (AC) (Ue)	230/400
Frequency (Hz)	50/60
Maximum Rated Current (A) (In)	32
Rated Breaking Capacity (True kA) (Ics)	6
Rated Insulation Voltage (V) (Ui)	500
Impulse Withstand Voltage (Uimp)	4000
Endurance Mechanical Operations	20000
Endurance Electrical Operations	8000
Trip Curve	B
Trip Type	Thermal/Magnetic Release
Thermal Operating limit	(1.13-1.45) x In
Magnetic Operating Characteristics	(3-5) x In
Device Terminals	Screwed Lug & Pin
MCB Terminal Capacity - Flexible (mm <sup>2</sup> )	25
MCB Terminal Capacity - Rigid (mm <sup>2</sup> )	35
MCB Terminal Torque (Nm)	2
Number Of Poles	1
Ingress Protection	IP20
Operational Temperature (°C)	-5 to +40
Warranty (Years)	3

**Standards** BS EN 60898-1

**Additional Information** For cleaning / polishing of products, use only a soft, dry, clean cloth.

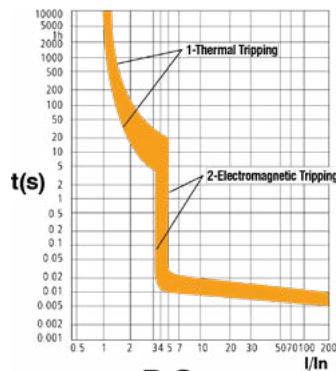

**B Curve**



Catalogue



Range



DoC

