

The Complete Consumer Unit



Get to know us

Elucian by Click® brings to market a comprehensive Consumer Unit and Circuit Protection range.

Following months of extensive research and consultation with contractors and installers, we developed a range of products that best suits their requirements and that are complaint with all the latest regulations.

Designed with the installer in mind, Elucian is an extensive range of metal consumer units that will cover a broad range of installations and offers a number of features and benefits that will enhance the products' convenience, flexibility and safety properties.



www.elucian.com



Keeping Up with Regulations...

The Elucian consumer units range has been designed to ensure compliance with BS 7671. Our engineers have considered how installers need to comply with the UK wiring regulation when installing consumer units in properties across the UK. The Elucian range has comprehensive options for every installation. These consist of Main Switch units, RCBO units, Split Load units and our Combination units.

Overload Protection (536.4.3.2) & (536.4.202)

Overload protection must be considered when RCCBs have the ability to become overloaded due to the total amount of current being taken by the final circuits being offered protection.

The designer and installer must therefore select the correct rated device from the options we have made available; 63Amp, 80Amp or 100Amp. To make this process easier we have installed 80Amp devices as standard.

Overcurrent Protection (Section 443) & (Section 553)

SPDs offer very effective protection against overvoltage. Section 443 covers the requirements for consideration when selecting SPDs in the electrical system.

Section 533 confirms what SPDs are required and where they must be installed within the electrical system.

We have designed our SPD consumer unit to incorporate a type 2 device. These devices offer protection from man-made overvoltages or lightning strikes within the vicinity of the installation.

Having SPDs installed adjacent to the main switch allows for compliance with the maximum cable length from the SPD to Earth.

Types of RCD (531.3.3)

Many different types of RCD exist. BS 7671 recognises types AC, A, F and B. Currently AC RCDs are recognised as acceptable for general purpose. However, if the installation has any DC components or frequency alterations due to connected loads one of the other types must be selected.

As most installations in the UK now have some DC components, it would be prudent to select a type A RCD that has the ability to work with DC fault current. We have produced type A RCDs only as they comply with the requirements of the AC type, they include added benefits of the DC threshold.

Division of Installation (Section 314)

This regulation set requires the designer and installer to ensure the installation is divided up as necessary to:

- (i) Avoid danger and minimise inconvenience in the event of a fault.
- (ii) Facilitate safe inspection, testing and maintenance.
- (iii) Take account of hazards that may arise from the failure of a single circuit such as a lighting circuit.
- (iv) Reduce the possibility of unwanted tripping of RCDs due to excessive protective conductor current or due to fault.
- (v) Mitigate the effects of electromagnetic disturbances.
- (vi) Prevent the indirect energization of a circuit intended to be isolated.

Overload Protection of RCCDs...

These devices have the ability to be overloaded if the combined outgoing current from the final circuits is greater than the rating of the RCCB. Therefore, we provide an 80Amp device as standard with the ability to change this to a 100Amp, or reduce to a 63Amp if required.

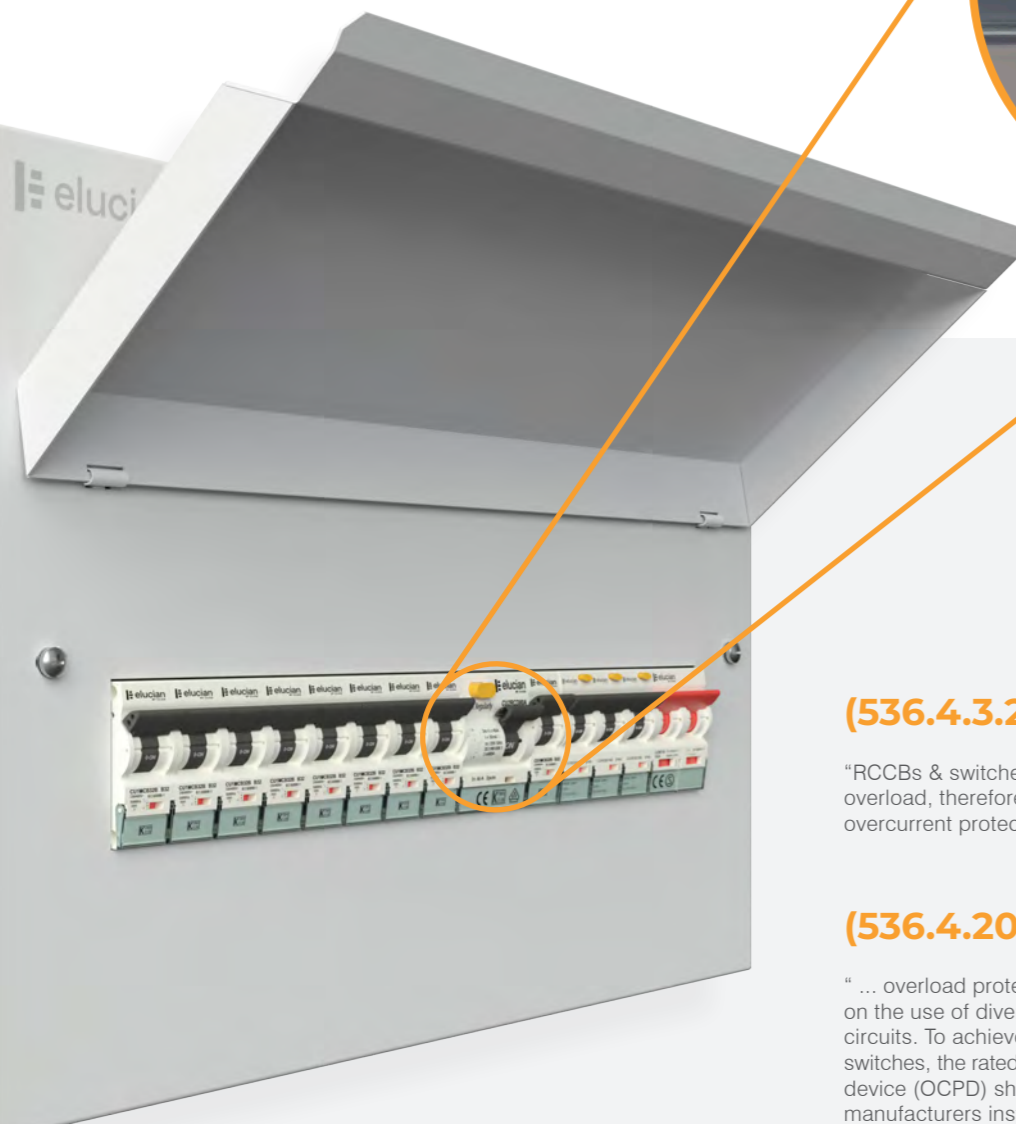

(536.4.3.2)

"RCCBs & switches do not provide protection against overload, therefore they shall be protected by an overcurrent protective device."

(536.4.202)

"... overload protection shall not solely be based on the use of diversity factors of the downstream circuits. To achieve overload protection of RCCBs or switches, the rated current of the over-current protective device (OCPD) shall be selected according to the manufacturers instructions".

Comply with the regs...

Regulations 536.4.3.2 and 536.4.202 require the designer to understand the loading profile of the RCCBs within the consumer unit. RCCBs will protect a number of outgoing circuits at the same time.

Method 1

Ensure the full load of all final circuits being protected are less than the rating of the RCCB. The installer will need to consider diversity for the final circuits but, not use diversity as the sole factor for calculating the total current downstream of the device.

Method 2

Ensure the main protective device is of a size to limit the total amount of amps upstream of the devices.

Example 1:

This install would not comply. RCCB1 could be subject to overload.

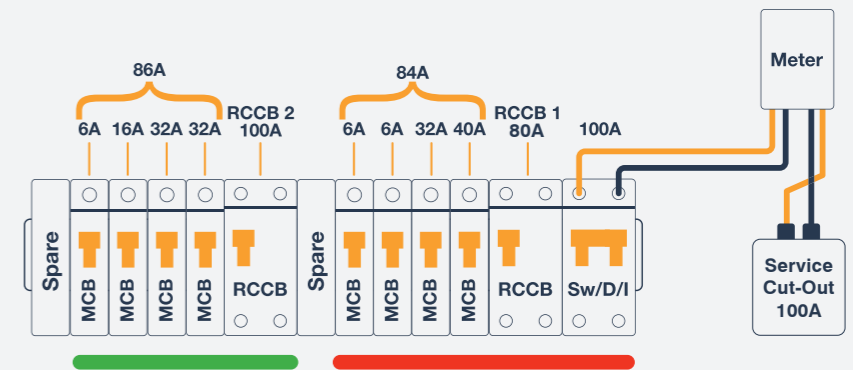

Example 2:

This installation would comply. Although RCCB1 could potentially become overloaded, the protective device at the origin would offer overload protection.

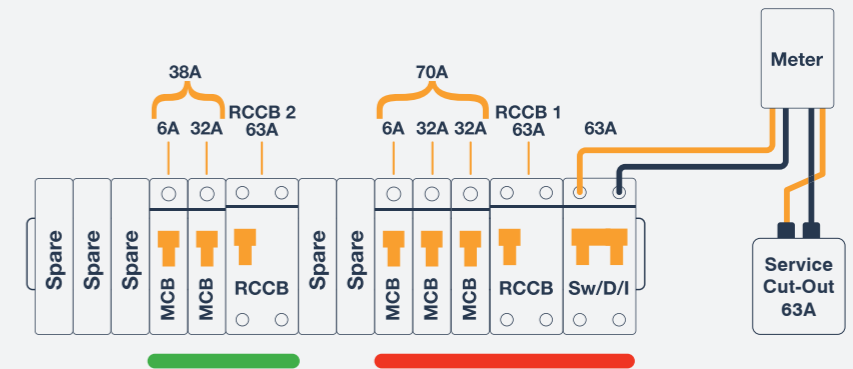

Example 3:

RCBOs offer comprehensive protection as each device is rated to the circuit.

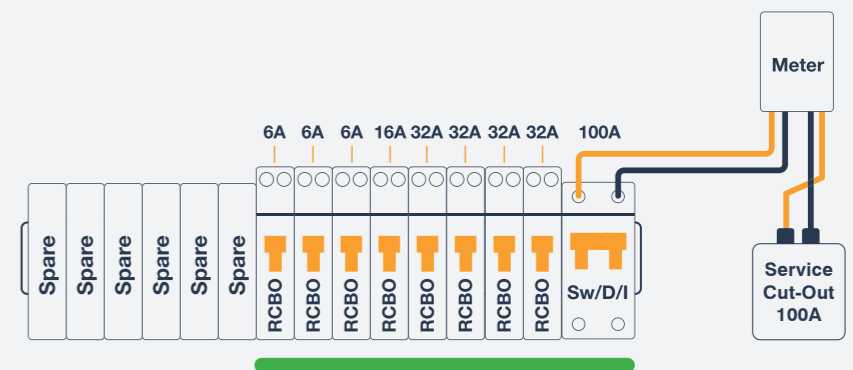

RCD & RCBO

Protective Devices...

RCDs are available in a number of common types; AC, A, F or B. Dependant on the characteristics of the final circuit/s being controlled, the type of RCD selected is very important. If it is believed DC current could be present in the protected circuit/s due to the equipment connected, the designer should select a device capable of working with that DC current present.

General RCDs are designed to operate instantaneously without intentional delay; because of this they are not designed to discriminate in the event of a fault. Therefore, if two general RCDs were to be installed in series, both may operate when a fault presents itself. To avoid this, selectivity is essential between the installed devices to reduce the unintentional operation of a device upstream from the leakage to Earth.

Installing the correct type of device is essential if it is believed DC fault current could be present within the installation. It is important not to install an RCD type that is capable of handling DC fault current ahead of a device that isn't able to operate with these currents.

Such as:

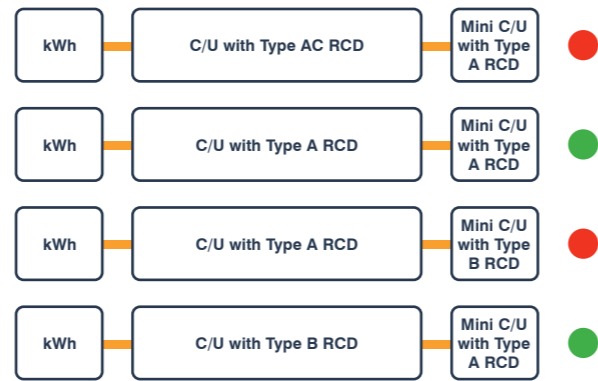

Type A RCD

In today's installations the majority of equipment does have some residual DC current due to the internal electronics. The magnitude of this current can have a detrimental effect on the effectiveness of the protective device. Therefore, we have taken the decision to manufacture Type A devices only.

Type A devices have the ability to continue to work with up to 6mA of DC fault current present. This amount of fault current has been shown to stop AC Type RCDs/RCBOs from working within the maximum time permitted in BS76761.

RCCB - Residual Current Operated Circuit Breaker, without integrated overcurrent protection.



RCBO Protection

These devices combine the functionality of an MCB and RCD into one single device/module. Available as a Type A RCD with different inrush curve types B or C, these protective devices have been miniaturised to maximise the available space above for termination or final circuits.

The Neutral fly lead has been made long enough to ensure safe connection to the dedicated Neutral bars.

RCBO - Residual Current Operated Circuit Breaker, with integrated overcurrent protection.

Surge Protection...

Transient Overvoltages

Many installations across the UK have electronic components within them. Surge protection will offer those devices and appliances protection from overvoltage.

Products such as computers, printers, flat screen televisions, alarms, microwaves and washing machines are commonplace. These can all be vulnerable to transient overvoltages, which can significantly reduce the equipment's lifespan through degradation and damage.

A transient overvoltage or surge is a short duration increase in voltage measured between two or more conductors. In short, this means anything from microseconds (millionths of a second) to a few milliseconds (thousandths of a second) in duration.

Example

A domestic consumer unit with 500m of LV supply overhead (L_{pa}) and 500m of supply underground (L_{pd});

$$CRL = f_{env} / (L_p \times N_g)$$

$$CRL = 85 / (2 \times 0.5) \times 0.5$$

$$CRL = 170$$

Which means that surge protection will be required.

Covers Overvoltage Control (443.5)

Calculated risk level (CRL) is used to determine if protection against overvoltages of atmospheric origin is required. The CRL is found by the following formula:

$$CRL = f_{env} / (L_p \times N_g)$$

f_{env} - is an environmental factor selected according to Table 443.1 (Rural/Suburban or Urban)

L_p - is the risk assessment length in km

N_g - is the lightning ground flash density (flashes per km² per year) relevant to the location of the power line and connected structure (see figure 44.2).

If the CRL value is less than 1000 then SPD protection should be installed.
If the CRL value is 1000 or more then SPD protection is not required.

Covers Overvoltage Control (443.4)

Protection against overvoltages shall be provided where the consequence caused by overvoltage could:

- (i) Result in serious injury to, or loss of, human life.
- (ii) Result in the interruption of public services and/or damage to cultural heritage.
- (iii) Result in interruption of commercial or industrial activity.
- (iv) Affect a large number of co-located individuals.

For all other cases, a risk assessment according to regulation 443.5 shall be performed to determine if protection against transient over-voltage is required. If the risk assessment is not performed, the electrical installation shall be provided with protection against transient over-voltages, except for single dwelling units where the total value of the installation and equipment therein does not justify such protection.

Protection against switching overvoltages shall be considered in the case of equipment likely to produce switching overvoltages or disturbances exceeding the values according to the voltage category of the installation, e.g. where an LV generator supplies the installation or where inductive or capacitive loads (e.g. motors, transformers, capacitor banks) storage units or high-current loads are installed.



SPD Type 2

SPD which can prevent the spread of over-voltages in the electrical installations and protects equipment connected to it. It usually employs metal oxide varistor (MOV) technology and is characterised by an 8/20 μ s current wave.

Terminology

I_{imp} - Impulse current of 10/350 μ s waveform.

I_n - Surge current of 8/20 μ s waveform associated with Type 2 SPDs.

U_p - The residual voltage that is measured across the terminal of the SPD when I_n is applied.

U_c - The maximum voltage which may be continuously applied to the SPD without it conducting.

I_{max} - Maximum short circuit current of the device.



Elucian Consumer Unit Range

 elucian

Consumer Units

Functional, stylish, and innovative, our Elucian range of consumer units provides an exceptional option for any residential or light commercial environment. Packed with features making installation quick and simple for electricians, with a clear labelling kit for easy identification for the customer. A great range of configurations and sizes makes Elucian perfect for any installation requirement.



01

Features & Benefits...



Metal Consumer Units

All Elucian consumer units are constructed using non combustible and robust metal housings. They ensure compliance against the third amendment which was added to the BS 7671 wiring regulations in 2015 requiring consumer units in domestic premises to have a non-combustible enclosure.



Mains Switch Tail Clamp

Each consumer and mini unit come supplied and pre-fitted with a Mains Switch Tail Clamp for added stress relief to ensure the Mains Tail terminations do not come loose and to help fix the Mains Switch Isolator more securely to prevent any rocking or movement. The Mains Switch Tail Clamp will accept a maximum of 25mm² double insulated tails.

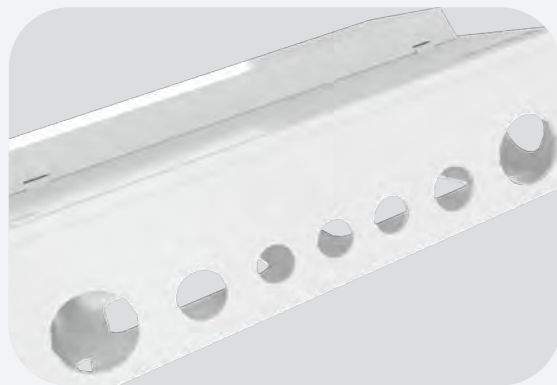

Variable Knockout Sizes

The units all come supplied with a wide range of 40mm, 32mm, 25mm and 20mm knockouts making each board universally adaptable for all installation and cable types.



Rear Knockouts

The units also come supplied with rear knockouts to provide ample cabling capacity for any installation type. Each knockout will be supplied with a 0.5M grommet strip to allow a smooth entry into the board, protecting cable from any potential sharp edges.



Shrouded Live Bus Bar

Our live bus bar comes supplied with the shroud pre-fitted for extra safety and convenience. Our Neutral and Earth Bus Bars are supplied with backed off screws allowing a faster installation



Accessories Pack

Contains a Sticker Set for clear circuit identification and caution warnings, Grommet Knockout Strips, 2 x Blank Modules, a detailed instruction sheet for all recommended installation details and a Live Bus Bar, Cover and Caps for added insulation and installation completion.

Consumer Unit Breakdown...

Large Space for Wiring

Each consumer unit has a large space for wiring, suitable for the increasing demands and circuit ways on a consumer unit.

Non-Combustible Enclosures

Non-combustible and robust metal housings ensure compliance against the third amendment added to the BS 7671 wiring regulations.

Earth and Neutral Bar

Each unit has its own specifically configured Earth and Neutral Bar to allow for best practice installation of each board type.

Torque Rating Label

There is a handy Torque rating label inside every consumer unit, allowing you to make all terminations with ease.

Grommet Strip

Each knockout will be supplied with a 0.5M grommet strip to allow a smooth entry into the board, protecting cable from any potential sharp edges.

Compact RCBOs

The latest design in compact RCBOs leaves more than sufficient space for cabling and terminating.

Keyway DIN Rail

A fast release Keyway DIN Rail allows for ease of installation.

MCB Style Solid Blanks

These are DIN Rail mountable and can only be removed when the cover is removed, thus providing additional safety. Other types of blanks can easily fall out or become dislodged.

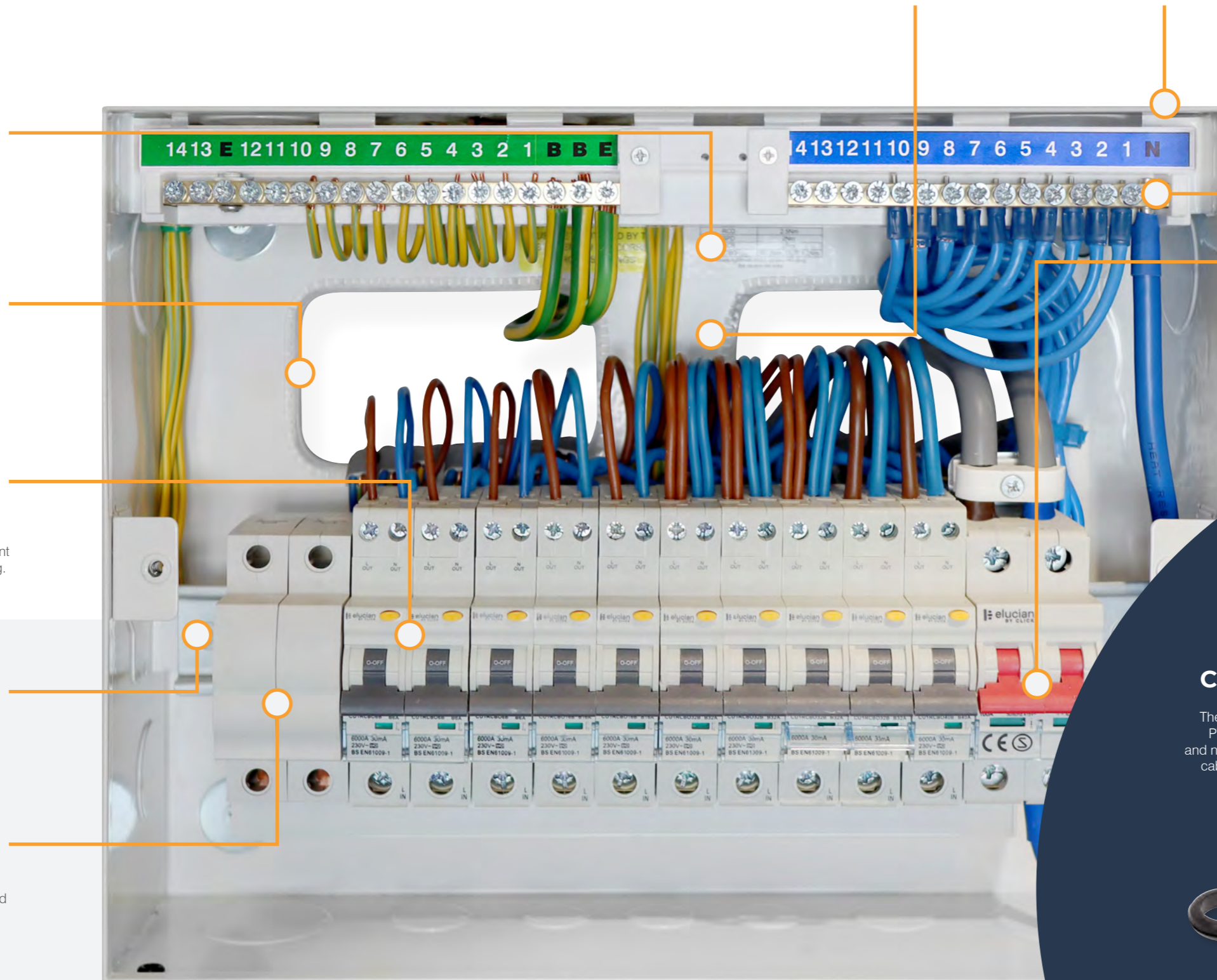

Lock Off Capabilities

Lockout devices are designed to attach to the moving part of the protective device, usually a switch toggle (rocker switch) which moves from the on to off position.

UNICRIMP®

Complete the Installation...

The Unicrimp® range includes cable ties, crimp terminals, PVC tape, copper tube terminals, cable clips, and brass and nylon glands – providing everything required to harness cable between the consumer unit and the end accessory.





Terminal Layouts...

8 Way - Neutral & Earth Terminal Configuration



10 Way - Neutral & Earth Terminal Configuration



12 Way - Neutral & Earth Terminal Configuration



14 Way - Neutral & Earth Terminal Configuration



16 Way - Neutral & Earth Terminal Configuration



18 Way - Neutral & Earth Terminal Configuration



22 Way - Neutral & Earth Terminal Configuration



Straight Way Consumer Units

A range of Elucian Metal Consumer Units furnished with a 100A Mains Switch.



* Example shown - CUEB12MS10

Available in...

CUEB8MS6 8 Way Metal Consumer Unit with 100A Mains Switch (6 Free Ways)	222mm (W) x 260mm (H) x 92mm (D)
CUEB10MS8 10 Way Metal Consumer Unit with 100A Mains Switch (8 Free Ways)	258mm (W) x 260mm (H) x 92mm (D)
CUEB12MS10 12 Way Metal Consumer Unit with 100A Mains Switch (10 Free Ways)	294mm (W) x 260mm (H) x 92mm (D)
CUEB14MS12 14 Way Metal Consumer Unit with 100A Mains Switch (12 Free Ways)	330mm (W) x 260mm (H) x 92mm (D)
CUEB16MS14 16 Way Metal Consumer Unit with 100A Mains Switch (14 Free Ways)	366mm (W) x 260mm (H) x 92mm (D)
CUEB18MS16 18 Way Metal Consumer Unit with 100A Mains Switch (16 Free Ways)	402mm (W) x 260mm (H) x 92mm (D)
CUEB22MS20 22 Way Metal Consumer Unit with 100A Mains Switch (20 Free Ways)	474mm (W) x 260mm (H) x 92mm (D)



Split Load Consumer Units

A range of Elucian Metal Consumer Units furnished with a 100A Mains Switch and 2 x 80A Type A RCDs.



* Example shown - CUEB18MSRCD12

Terminal Layouts...

14 Way - Neutral & Earth Terminal Configuration

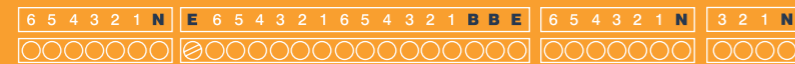

16 Way - Neutral & Earth Terminal Configuration



18 Way - Neutral & Earth Terminal Configuration



22 Way - Neutral & Earth Terminal Configuration



Available in...

CUEB14MSRCD8 14 Way Metal Consumer Unit with 100A Mains Switch + 2 x 80A 30mA RCD (4+4 Free Ways)	330mm (W) x 260mm (H) x 92mm (D)
CUEB16MSRCD10 16 Way Metal Consumer Unit with 100A Mains Switch + 2 x 80A 30mA RCD (5+5 Free Ways)	366mm (W) x 260mm (H) x 92mm (D)
CUEB18MSRCD12 18 Way Metal Consumer Unit with 100A Mains Switch + 2 x 80A 30mA RCD (6+6 Free Ways)	402mm (W) x 260mm (H) x 92mm (D)
CUEB22MSRCD16 22 Way Metal Consumer Unit with 100A Mains Switch + 2 x 80A 30mA RCD (8+8 Free Ways)	474mm (W) x 260mm (H) x 92mm (D)



Split Load Consumer Units with Surge Protection

A range of Elucian Metal Consumer Units furnished with a 100A Mains Switch, 2 x 80A Type A RCDs and a 2 Pole Type 2 275Uc (V~) 40kA SPD.



* Example shown - CUEB14MSRCDSP6

Terminal Layouts...

14 Way - Neutral & Earth Terminal Configuration

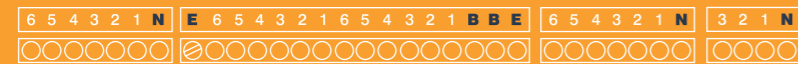

16 Way - Neutral & Earth Terminal Configuration



18 Way - Neutral & Earth Terminal Configuration



22 Way - Neutral & Earth Terminal Configuration



Available in...

CUEB14MSRCDSP6 14 Way Metal Consumer Unit with 100A Mains Switch + 2 x 80A 30mA RCD + 2 Pole SPD (3+3 Free Ways)	330mm (W) x 260mm (H) x 92mm (D)
CUEB16MSRCDSP8 16 Way Metal Consumer Unit with 100A Mains Switch + 2 x 80A 30mA RCD + 2 Pole SPD (4+4 Free Ways)	366mm (W) x 260mm (H) x 92mm (D)
CUEB18MSRCDSP10 18 Way Metal Consumer Unit with 100A Mains Switch + 2 x 80A 30mA RCD + 2 Pole SPD (5+5 Free Ways)	402mm (W) x 260mm (H) x 92mm (D)
CUEB22MSRCDSP14 22 Way Metal Consumer Unit with 100A Mains Switch + 2 x 80A 30mA RCD + 2 Pole SPD (7+7 Free Ways)	474mm (W) x 260mm (H) x 92mm (D)



Combination Consumer Units

A range of High Integrity Elucian Metal Consumer Units furnished with a 100A Mains Switch and 2 x 80A Type A RCDs.



* Example shown - CUEHIB16MSRCD10

Terminal Layouts...

14 Way - Neutral & Earth Terminal Configuration

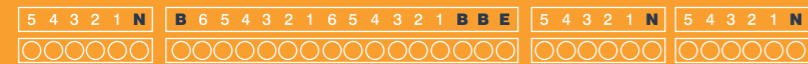

16 Way - Neutral & Earth Terminal Configuration



18 Way - Neutral & Earth Terminal Configuration



22 Way - Neutral & Earth Terminal Configuration



Available in...

CUEHIB14MSRCD8

14 Way High Integrity Metal Consumer Unit with 100A Mains Switch + 2 x 80A 30mA RCD (8 Free Ways)

330mm (W) x 260mm (H) x 92mm (D)

CUEHIB16MSRCD10

16 Way High Integrity Metal Consumer Unit with 100A Mains Switch + 2 x 80A 30mA RCD (10 Free Ways)

366mm (W) x 260mm (H) x 92mm (D)

CUEHIB18MSRCD12

18 Way High Integrity Metal Consumer Unit with 100A Mains Switch + 2 x 80A 30mA RCD (12 Free Ways)

402mm (W) x 260mm (H) x 92mm (D)

CUEHIB22MSRCD16

22 Way High Integrity Metal Consumer Unit with 100A Mains Switch + 2 x 80A 30mA RCD (16 Free Ways)

474mm (W) x 260mm (H) x 92mm (D)



Terminal Layouts...

5 Way - Neutral & Earth Terminal Configuration



Garage Consumer Units

A range of Elucian Metal Consumer Units ideal for garage installations. Furnished with either a 63A or 80A Type A RCD.



* Example shown - GUEBF80RCD3

Available in...

GUEB563RCD3	5 Way Metal Garage Unit with 63A RCD (3 Free Ways)	168mm (W) x 260mm (H) x 92mm (D)
GUEB580RCD3	5 Way Metal Garage Unit with 80A RCD (3 Free Ways)	168mm (W) x 260mm (H) x 92mm (D)

Keeping you
in Charge...



 elucian

Elucian Protective Devices Range

Protective Devices

Our Elucian range of Protective Devices are easy to install, suitable for residential and light commercial environments, they provide protection against earth faults to ensure people's safety against electrocution and fires.



elucian

02

Features & Benefits...

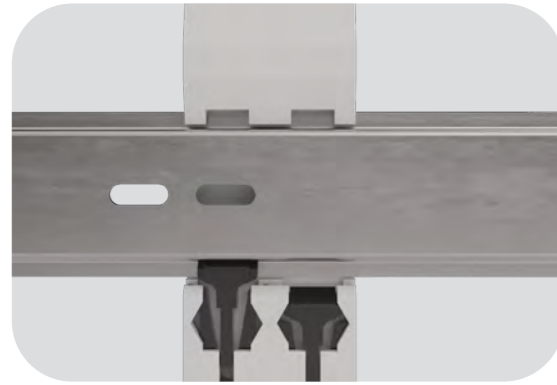

Clip in Devices

The Elucian Protective Devices simply click onto the DIN Rail and can be secured with this locking mechanism. This means work can be carried out quicker and without dealing with tight spaces.



Lock Off Capabilities

Lockout devices (available at Unicrimp®) are designed to attach to the moving part of the protective device, usually a switch toggle (rocker switch) which moves from the on to off position. This ensures the switch cannot be switched back on while work is being carried out.



Clear Indication

Each protective device has clear and visible trip indication along with clear product information which is easily visible whatever the switch position.









3 Year Product Warranty

We take pride in leading the market and our 3 year warranty offers the best peace of mind available as standard today. It reflects the confidence we have in our products and the benefit of years of continuous engineering improvement.

RCBO Devices

1 Pole + Neutral True 6kA B Curve & C Curve 30mA Trip RCBOs

- 
1 Pole + Neutral
- 
30mA
Trip Current
- 
6kA
True 6kA
- 
A
Type A
- 
Large Terminal
Capacity
- 
3YR
3 Year
Warranty

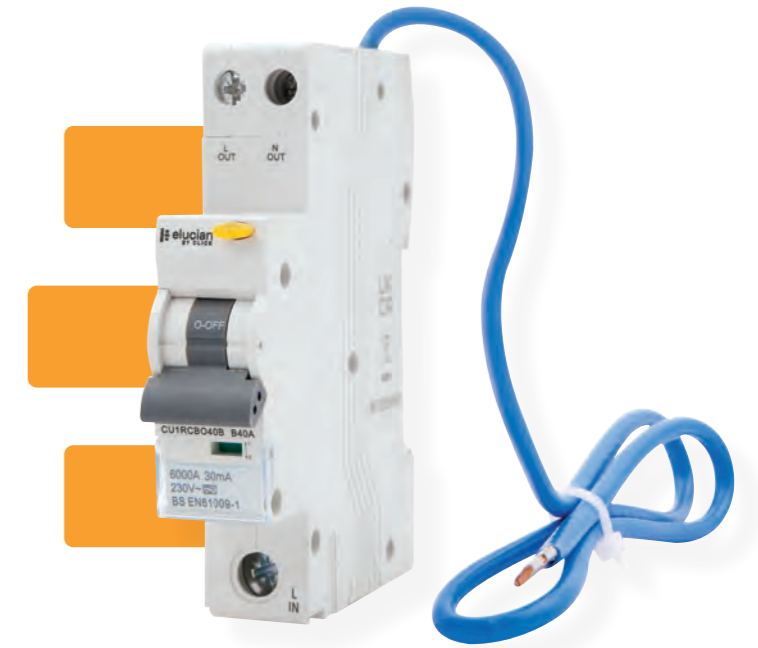





Available in...

CU1RCBO6B 1 Pole True 6kA B Curve 6A 30mA RCBO	CU1RCBO6C 1 Pole True 6kA C Curve 6A 30mA RCBO
CU1RCBO10B 1 Pole True 6kA B Curve 10A 30mA RCBO	CU1RCBO10C 1 Pole True 6kA C Curve 10A 30mA RCBO
CU1RCBO16B 1 Pole True 6kA B Curve 16A 30mA RCBO	CU1RCBO16C 1 Pole True 6kA C Curve 16A 30mA RCBO
CU1RCBO20B 1 Pole True 6kA B Curve 20A 30mA RCBO	CU1RCBO20C 1 Pole True 6kA C Curve 20A 30mA RCBO
CU1RCBO32B 1 Pole True 6kA B Curve 32A 30mA RCBO	CU1RCBO32C 1 Pole True 6kA C Curve 32A 30mA RCBO
CU1RCBO40B 1 Pole True 6kA B Curve 40A 30mA RCBO	CU1RCBO40C 1 Pole True 6kA C Curve 40A 30mA RCBO

RCD Devices

2 Pole 30mA Residual Circuit Devices.

-  1 Pole + Neutral
-  Type A
-  Large Terminal Capacity
-  3 Year Warranty

Available in...

CU2RCD63A

2 Pole 63A 30mA RCD

CU2RCD80A

2 Pole 80A 30mA RCD







CU2RCD100A

2 Pole 100A 30mA RCD



MCB Devices



1 Pole, True 6kA B Curve & C Curve MCB Devices.

-  B Curve
-  C Curve
-  Single Pole
-  True 6kA
-  Large Terminal Capacity
-  3 Year Warranty



SPD Devices

2 Pole 40kA Surge Protection Device.

-  Double Pole
-  Response Time <math><25\text{ns}</math>
-  Max Discharge Current 40kA
-  Protection Level (UP) <math><1.6\text{kV}</math>
-  Large Terminal Capacity
-  3 Year Warranty

Available in...

CU2SPD275

2 Pole 275Uc (V~) 40kA Type 2 SPD



Available in...

CU1MCB6B

1 Pole True 6kA B Curve 6A MCB

CU1MCB10B

1 Pole True 6kA B Curve 10A MCB

CU1MCB16B

1 Pole True 6kA B Curve 16A MCB

CU1MCB20B

1 Pole True 6kA B Curve 20A MCB

CU1MCB25B

1 Pole True 6kA B Curve 25A MCB

CU1MCB32B

1 Pole True 6kA B Curve 32A MCB

CU1MCB40B

1 Pole True 6kA B Curve 40A MCB

CU1MCB50B

1 Pole True 6kA B Curve 50A MCB

CU1MCB63B

1 Pole True 6kA B Curve 63A MCB

CU1MCB6C

1 Pole True 6kA C Curve 6A MCB

CU1MCB10C

1 Pole True 6kA C Curve 10A MCB

CU1MCB16C

1 Pole True 6kA C Curve 16A MCB

CU1MCB20C

1 Pole True 6kA C Curve 20A MCB

CU1MCB25C

1 Pole True 6kA C Curve 25A MCB

CU1MCB32C

1 Pole True 6kA C Curve 32A MCB

CU1MCB40C

1 Pole True 6kA C Curve 40A MCB

CU1MCB50C





1 Pole True 6kA C Curve 50A MCB

CU1MCB63C

1 Pole True 6kA C Curve 63A MCB

Mains Switch Devices

2 Pole 100A Mains Isolator Switch.

-  Double Pole
-  100A Rated
-  Large Terminal Capacity
-  3YR Warranty

Available in...

CU2MS100
2 Pole 100A Mains Isolator Switch



Fused Main Switch

80A & 100A Fused Main Switches

80A
HRC Fuse Supplied

Available in...

- DB700**
80A Fused Main Switch (80A HRC Fuse Fitted)
- DB701**
80A Fused Main Switch (80A HRC Fuse Fitted) - Lockable
- DB750**
100A Fused Main Switch (80A HRC Fuse Fitted)
- DB751**
100A Fused Main Switch (80A HRC Fuse Fitted) - Lockable

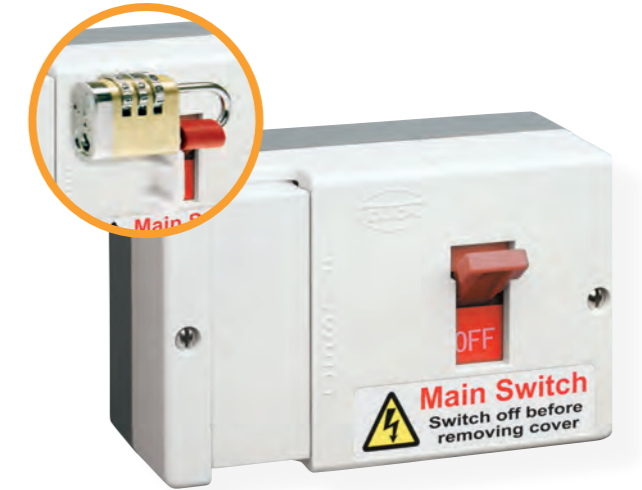

Blank Modules

Single way Din Rail Blank Module.

3YR
3 Year Warranty

Available in...

CU1BLANK
Single Way Din Rail Blank Module



Fused Main Switch Accessories

Enclosures and Cable Shrouds

Available in...

- DB790**
Metal Enclosure for Fused Main Switch (DB700/701)
* Suitable for DB700/701 80A fused main switch
- DB791**
Metal Enclosure for Fused Main Switch (DB750/751)
* Suitable for DB701/751 100A fused main switch
- DB981**
Elongated Cable Shroud (Packaged Individually)
* Enables surface and rear entry cable access
* Suitable for 35mm² cables





More from Scolmore® Group...

Click® Wiring Accessories

Scolmore® International is one of the UK's leading manufacturers of electrical accessories.

The company is proud to be a British-based, family-run business with an international reputation for quality, innovation and exemplary customer service.

From our Head Office in the Midlands, we design, develop and manufacture an ever expanding product range for distribution throughout the UK and worldwide.

The Click® Wiring Accessories range remains the number one choice of electricians and contractors who value the flexibility of the modular based range, as well as the one-stop solution that the comprehensive offer allows.

Scolmore House
Mariner, Lichfield Road Industrial Estate Tamworth, Staffordshire, B79 7UL, UK

+44 (0) 1827 63454
sales@scolmore.com
www.scolmore.com



Unicrimp® Cable Accessories

Unicrimp® brings to the electrical contracting industry a comprehensive range of cable accessory products.

All products within the Q-Crimp® range are manufactured under stringent quality control systems and are fully compliant with the very latest industry regulations.

The range includes cable ties, crimp terminals, PVC tape, copper tube terminals, cable clips, and brass and nylon glands. Also available under the Q-Fire brand are products to help you keep up to date with all the latest fire regulations.

Located close to the Scolmore Group Headquarters in the Midlands, the Unicrimp® distribution centre is ideally located to supply to all areas of the UK.

Scolmore House
Mariner, Lichfield Road Industrial Estate Tamworth, Staffordshire, B79 7UL, UK

+44 (0)1827 300600
sales@unicrimp.com
www.unicrimp.com



Lighting from Ovia®

Ovia® is an independent lighting brand established by Scolmore® in 2019.

Ovia® brings to market an extensive range of high quality, competitively-priced lighting and lighting control products that offer easy to install solutions across a variety of applications - commercial, industrial, domestic, utility, amenity, floodlighting and emergency lighting.

The comprehensive range was developed on the back of extensive research with customers and contractors and satisfies the requirements of an evolving lighting sector which has been transformed in recent years.

Scolmore House
Mariner, Lichfield Road Industrial Estate Tamworth, Staffordshire, B79 7UL, UK

+44 (0) 1827 300640
sales@oviaUK.com
www.oviauk.com



United Kingdom



Scolmore House
Mariner, Lichfield Road Industrial Estate
Tamworth, Staffordshire, B79 7UL

+44 (0) 1827 63454
sales@scolmore.com
www.scolmore.com



Southern Ireland



18 Corrig Road,
Sandyford Industrial Estate,
Dublin, D18 WW79, Ireland

T: +353 (1) 2811 122
F: +353 (1) 2811 224
E: sales@clicklitehouse.ie
www.clicklitehouse.ie



Dubai, UAE



Lake Central Tower,
Office 1803, Business Bay,
Dubai, UAE

UAE Office: +971 4589 6552
F: +971 52 451 1164
E: sales@scolmoredubai.com
www.scolmoredubai.com

